

jura®



J6 Instructions for Use



Your J6

Control elements	4
Important information	6
Proper use	6
For your safety	6
1 Preparing and using for the first time	10
JURA on the Internet	10
Setting up the machine	10
Filling the bean container	10
Determining the water hardness	10
First-time use	11
Connecting milk	14
Connect accessory (wireless connection)	14
2 Preparation	15
Ways of preparing a beverage	15
Ristretto, espresso and coffee	16
Two ristretti, two espressi and two coffees	16
Latte macchiato, cappuccino and other speciality coffees with milk	17
Ground coffee	17
Permanently setting the amount of water for the cup size	18
Adjusting the grinder	19
Hot water	19
3 Daily operation	20
Filling the water tank	20
Switching on the machine	20
Daily maintenance	21
Regular maintenance	21
Switching off the machine	22
4 Permanent settings in programming mode	23
Adjusting the product settings	24
Adding products to the start screen, duplicating and personalising	25
Automatic switch-off	26
Energy-saving mode	27
Setting the water hardness	27
Display settings	28
Unit for amount of water	28
Restore factory settings	29
Language	29
Querying information	30
5 Maintenance	31
Rinsing the machine	31
Automatic milk system rinsing	32
Cleaning the milk system	32

Dismantling and rinsing the cappuccino frother	33
Inserting the filter	34
Changing the filter	34
Cleaning the machine	35
Descaling the machine.....	36
Cleaning the bean container.....	38
Descaling the water tank.....	39
6 Display messages	40
7 Troubleshooting	41
8 Transport and environmentally friendly disposal	43
Transport / Emptying the system.....	43
Disposal.....	43
9 Technical data	44
10 Index	45
11 JURA contact details / Legal information	48

Symbol description

Warnings

 WARNING	Always take note of any information marked with the words CAUTION or
 CAUTION	WARNING and a warning sign. The signal word WARNING draws your attention to potential serious injury, and the signal word CAUTION to potential minor injury.
CAUTION	CAUTION draws your attention to potential damage to the machine.

Symbols used

	Prompt to take action. This symbol means that you are being prompted to perform some action.
---	---

	Information and tips to make it even easier to use your JURA.
---	--

	Display
---	----------------

Control elements

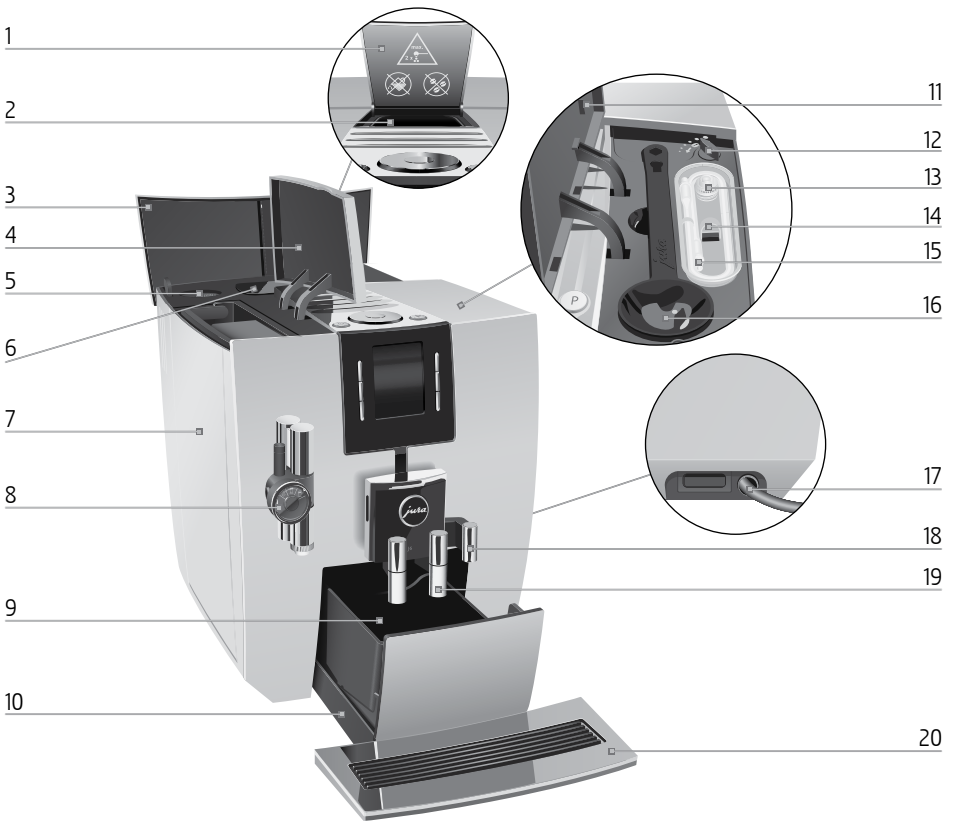

- | | | | |
|----|--|----|---|
| 1 | Filler funnel cover | 11 | Storage compartment cover |
| 2 | Filler funnel for ground coffee | 12 | Grinder adjustment switch |
| 3 | Bean container cover | 13 | Interchangeable milk spout |
| 4 | Water tank cover | 14 | Storage compartment insert |
| 5 | Service socket | 15 | Milk pipe |
| 6 | Bean container with aroma preservation cover | 16 | Measuring spoon for ground coffee |
| 7 | Water tank | 17 | Mains cable (side of machine) |
| 8 | Height-adjustable cappuccino frother | 18 | Hot-water spout |
| 9 | Coffee grounds container | 19 | Height- and width-adjustable coffee spout |
| 10 | Drip tray | 20 | Cup grille |

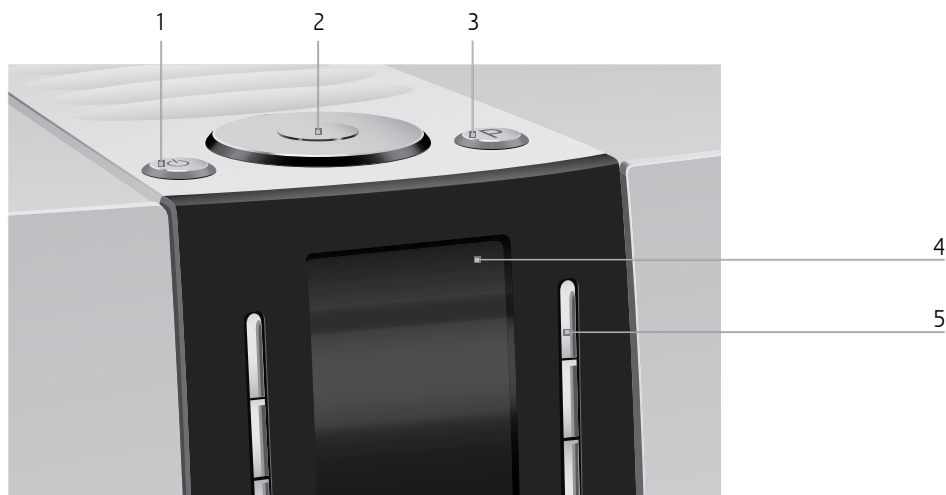

Top of the machine

- 1 On/Off button 
- 2 Rotary Switch
- 3 P button (programming)

Front

- 4 Display
- 5 Multi-function buttons (button function depends on what is shown in the display)

Container for milk system cleaning



Important information

Proper use

The machine is designed and intended for private domestic use. It should only be used for coffee preparation and to heat milk and water. Use for any other purpose will be deemed improper. JURA Elektroapparate AG cannot accept any responsibility for the consequences of improper use.

Before using the machine read these instructions for use thoroughly and completely and comply with the instructions they contain. A warranty service is not applicable for damage or defects caused by non-compliance with the instructions for use. Keep these instructions for use close to the machine and pass them on to the next user.

For your safety

Please carefully read and observe the important safety information set out below.



To avoid danger of potentially fatal electric shock:

- Never use a machine which is damaged or has a defective mains cable.
- In the event of signs of damage, for example if there is a smell of burning, unplug the machine immediately from the mains supply and contact JURA service.
- If the mains cable of this machine is damaged, it must be repaired either directly by JURA or by an authorised JURA service centre.
- Make sure that the JURA and the mains cable are not located close to hot surfaces.
- Be careful to ensure that the mains cable is not trapped and does not rub against sharp edges.

- Never open and repair the machine yourself. Do not modify the machine in any way that is not described in these instructions for use. The machine contains live parts. If opened, there is a danger of potentially fatal injury. Repairs may only be carried out by authorised JURA service centres, using original spare parts and accessories.
- To completely and safely disconnect the machine from the power supply, first switch off the JURA using the On/Off button. Only then should you remove the mains plug from the power socket.

There is a risk of scalds or burns on the spouts and the cappuccino frother.

- Place the machine out of the reach of children.
- Do not touch any hot parts. Use the handles provided.
- Ensure that the cappuccino frother is correctly fitted and clean. If incorrectly fitted or if they become blocked, the cappuccino frother or its parts might come off. There is a danger of parts being swallowed.

A defective machine is not safe and could cause injury or fire. To avoid damage and any associated risk of injury or fire:

- Never allow the mains cable to loosely hang down. The mains cable could pose a tripping hazard or become damaged.
- Protect the JURA from environmental influences such as rain, frost and direct sunlight.
- Do not immerse the JURA, mains cable or connections in water.

Important information

- Do not put the JURA or any individual parts in the dishwasher.
- Switch your JURA off at the power switch before any cleaning operation. Always wipe the JURA with a damp cloth rather than a wet one, and protect it from prolonged exposure to water splash.
- On models with glass cup grille: Do not subject the glass cup grille to shock or impact.
- Only connect the machine to the mains voltage in accordance with the information on the rating plate. The rating plate is located on the underside of your JURA. Further technical data is provided in these instructions for use (see Chapter 9 'Technical data').
- Connect the JURA directly to a domestic power socket. Using multi-socket adapters or extension cords may cause overheating.
- Please only use original JURA maintenance products. Use of products that are not explicitly recommended by JURA could damage the machine.
- Do not use alkaline cleaning agents; only use a soft cloth and mild cleaning agents.
- Do not use any coffee beans treated with additives or caramelised coffee beans.
- Only fill the water tank with fresh, cold water.
- Switch the machine off at the power switch if you are going to be absent for a longer period of time.
- Children may not clean or service the machine unless supervised by a responsible person.
- Do not allow children to play with the machine.
- Keep children under the age of 8 away from the machine, or supervise them constantly.

- Children aged 8 and over may only operate the machine without supervision if they have been instructed in how to use it safely. Children must be able to recognise and understand the potential dangers arising from incorrect use.

People, including children, who

- do not have the physical, sensory or mental capabilities to use the machine safely or
- are inexperienced or lack knowledge in how to use the machine safely

must be supervised by a responsible person when using it, or must be instructed in how to use it correctly.

Safety when handling the CLARIS Smart filter cartridge:

- Filter cartridges should be kept out of the reach of children.
- Store filter cartridges in a dry place in the sealed packaging.
- Protect cartridges from heat and direct sunlight.
- Do not use damaged filter cartridges.
- Do not open filter cartridges.
- The CLARIS Smart filter cartridge communicates with your J6 via RFID technology (frequency band 13.56 MHz). This wireless connection is only used for a maximum of 3 sec. during preparation. In this case, the maximum transmission power is below 1 mW.

1 Preparing and using for the first time

JURA on the Internet

Visit us on the Internet. You can download **short operating instructions** for your machine from the JURA website (jura.com). You will also find interesting and up-to-date information on your JURA and on every aspect of coffee.

Setting up the machine

When setting up your JURA, please note the following:

- Place the JURA on a horizontal surface that is not sensitive to water.
- Choose a spot for your JURA which protects the machine against overheating. Ensure that the ventilation slots are not covered.

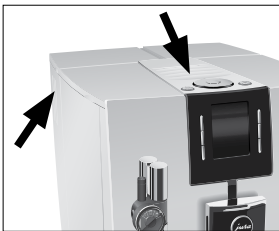

Filling the bean container

The bean container has an aroma preservation cover. This will ensure that your coffee beans retain their aroma for longer.

CAUTION

Coffee beans which have been treated with additives (e.g. sugar), ground coffee or freeze-dried coffee will damage the grinder.

- ▶ Only use roasted, untreated coffee beans to fill the bean container.

-
- ▶ Open the bean container cover and remove the aroma preservation cover.
 - ▶ Remove any dirt or foreign objects from inside the bean container.
 - ▶ Fill the bean container with coffee beans, then close the aroma preservation cover and the bean container cover.

Determining the water hardness

When you use the machine for the first time, you must set the water hardness. If you do not know the hardness of your water, you can find this out first. Use the Aquadur® test strips supplied with the machine.

- ▶ Hold the test strip briefly (for 1 second) under flowing water. Shake off the water.

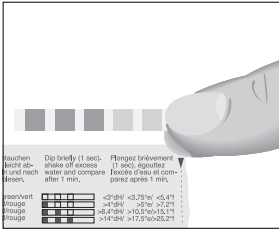

- ▶ Wait for about 1 minute.
- ▶ You will then be able to read the degree of water hardness from the discolouration of the Aquadur® test strip and the description on the packaging.

First-time use

When using the machine for the first time, you can choose whether you want to operate JURA **with** or **without** the CLARIS Smart filter cartridge. As well as limescale, the filter cartridge filters many other substances that impair aroma and flavour out of the water. These substances may negatively affect the coffee. To enjoy the best quality coffee at all times, we recommend that you use CLARIS Smart.

⚠ WARNING

If the machine is operated with a defective mains cable, there is a danger of potentially fatal electric shock.

- ▶ Never use a machine which is damaged or has a defective mains cable.

Precondition: The bean container has been filled.

- ▶ Insert the mains plug into a power socket.
- ▶ Press the On/Off button  to switch the JURA on.
‘Sprachauswahl’ / ‘Deutsch’
- i** To view more languages, turn the Rotary Switch.
 - ▶ Turn the Rotary Switch until the required language is displayed, e.g. **‘English’**.
 - ▶ Press the **‘Save’** button.
‘Saved’ appears briefly on the display to confirm the setting.
‘Water hardness’
- i** If you do not know the hardness of your water, you must find this out first (see Chapter 1 ‘Preparing and using for the first time – Determining the water hardness’).
 - ▶ Turn the Rotary Switch to change the water hardness setting, e.g. to **‘25 °dH’**.

1 Preparing and using for the first time

- ▶ Press the 'Save' button.
'Saved' appears briefly on the display.
'Insert filter'

i Now decide whether you want to operate your JURA **with** or **without** a CLARIS Smart filter cartridge.

Operation **with** filter cartridge: go straight to the next section.

Operation **without** filter cartridge: see Chapter 1 'Preparing and using for the first time – First-time use without filter cartridge activation'.

First-time use with filter cartridge activation

CAUTION

Milk, sparkling mineral water or other liquids can damage the water tank or the machine.

- ▶ Only fill the water tank with fresh, cold water.



- ▶ Place one receptacle under the hot-water spout and another under the cappuccino frother.
- ▶ Remove the water tank and rinse it with cold water.
- ▶ Open the filter holder.
- ▶ Fit the filter cartridge extension supplied on top of a CLARIS Smart filter cartridge.



- ▶ Insert the filter cartridge with its extension into the water tank.
- ▶ Close the filter holder. It will click into place audibly.
- ▶ Fill the water tank with fresh, cold water and reinsert the tank.

i The machine automatically detects that you have just inserted the filter cartridge.

'Filter operation' / 'Saved'

'Filter is being rinsed', water flows out of the hot-water spout.

Rinsing of the filter stops automatically after approximately 300 ml.

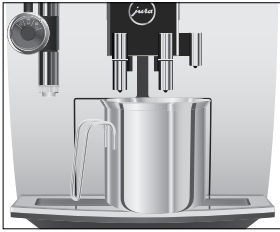

‘System is filling’, water flows out of the cappuccino frother.
‘Empty drip tray’

- ▶ Empty the drip tray and put it back into the machine.
- ▶ Place a receptacle under the coffee spout.

‘Machine is heating’

‘Machine is rinsing’, the system is rinsed. The rinse stops automatically. ‘Please select product’ appears on the display.
Your JURA is ready for use.

- i** The display shows the products you can prepare.
- i** If the filter is active, this is indicated by a blue filter symbol in the top right of the display.

First-time use without filter cartridge activation

CAUTION

Milk, sparkling mineral water or other liquids can damage the water tank or the machine.

- ▶ Only fill the water tank with fresh, cold water.



- ▶ Press the ‘No filter’ button.

‘Descaling mode’ / ‘Saved’

‘Fill water tank’

- ▶ Place a receptacle under the cappuccino frother, the coffee spout and the hot-water spout.



- ▶ Remove the water tank and rinse it with cold water.
- ▶ Fill the water tank with fresh, cold water and reinsert the tank.

‘System is filling’, the system fills up with water.

‘Machine is heating’

‘Machine is rinsing’, water flows out of the coffee spout. The rinse stops automatically. Your JURA is ready for use.

- i** The display shows the products you can prepare.

Connecting milk

Your JURA creates fine, creamy, feather-light milk foam with a perfect consistency. The most important requirement for frothing milk is a milk temperature of 4–8 °C. We would therefore recommend using a milk cooler or a milk container.

i Suitable milk containers from JURA are available from specialised dealers.

▶ Remove the protective cover from the cappuccino frother.

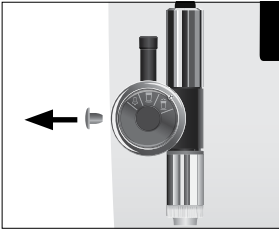

▶ Attach the milk pipe to the cappuccino frother.

▶ Connect the other end of the milk pipe to a milk container or a milk cooler.

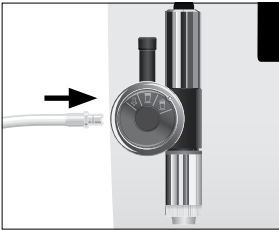

Connect accessory (wireless connection)

You have the option of connecting your JURA wirelessly to a compatible accessory (e.g. the Cool Control Wireless milk cooler). To do this, the receiver of the Cool Control or the JURA Smart Connect must be plugged into the service socket.

A frequency band of 2.4 GHz is used for this wireless connection. In this case, the maximum transmission power is below 1 mW.

▶ Press the P button.

‘Maintenance status’

▶ Turn the Rotary Switch until ‘Machine settings’ is displayed.

▶ Press the Rotary Switch.

‘Choose language’

▶ Turn the Rotary Switch until ‘Connect accessory’ is displayed.

▶ Press the Rotary Switch to enter the programme item.

‘Connect accessory’

▶ Press the ‘Next’ button.

▶ Now follow the instructions on the display to connect the accessory to the JURA.

2 Preparation

Basic information about preparing drinks:

- During the grinding operation you can select the coffee strength of **single products** by turning the Rotary Switch.
- During preparation, you can change the preset **amounts** (e.g. amount of water or milk) by turning the Rotary Switch.
- You can stop the machine at any time while a speciality coffee or hot water is being prepared. To do this, press the ‘**⏏**’ button or the Rotary Switch.

Coffee tastes best served hot. A cold porcelain cup cools the beverage – and impairs the taste. We therefore recommend prewarming the cups. The full coffee aroma can develop only in prewarmed cups. You can purchase a JURA cup warmer from your specialised dealer.

You can make **permanent settings** for all products in programming mode (see Chapter 4 ‘Permanent settings in programming mode – Adjusting the product settings’).

Ways of preparing a beverage

The JURA offers various ways of preparing a speciality coffee, milk or hot water:

- **Preparation using the start screen:** Simply press the corresponding preparation button for the product shown on the display (start screen) that you want.

The following products are displayed as standard:

- ‘Cappuccino’
- ‘Latte macchiato’
- ‘1 portion milk’
- ‘Espresso’
- ‘Coffee’
- ‘Hot water’

- **Using the product selector view (Rotary Selection):** Only some of the products you can prepare are shown on the start screen. As soon as you turn the Rotary Switch, more products are displayed in a **product selector view**.

Turn the Rotary Switch to bring the product you want into focus. Start preparation by pressing the Rotary Switch.

The following additional products are shown in the product selector view:

- 'Ristretto'
- 'Flat White'
- 'Macchiato'

- i** The product selector view disappears automatically after 10 seconds if no preparation is started.
- i** You can move any of the standard products programmed in your JURA to your preferred position on the start screen or in the product selector and make it one of your favourites. You can duplicate and personalise your favourite speciality coffees by giving them a new product name and individual settings (e.g. amount and coffee strength) (see Chapter 4 'Permanent settings in programming mode – Adding products to the start screen, duplicating and personalising'). Please note that the descriptions provided in the following sections always refer to the default settings.

Ristretto, espresso and coffee

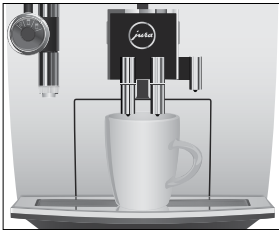

Example: Proceed as follows to prepare one coffee.

- ▶ Place a cup under the coffee spout.
- ▶ Press the 'Coffee' button.
Preparation starts. 'Coffee' and the coffee strength are displayed. The preset amount of water for coffee flows into the cup.
Preparation stops automatically. Your JURA is once more ready for use.

Two ristretti, two espressi and two coffees



To prepare **two** speciality coffees, press the appropriate preparation button twice (within approximately 2 seconds).

Example: Proceed as follows to prepare two espressi.

- ▶ Place two cups under the coffee spout.
- ▶ Press the 'Espresso' button **twice (within 2 seconds)** to start preparation.
'2 x Espresso' appears and the preset amount of water flows into the cups.
Preparation stops automatically. Your JURA is once more ready for use.

Latte macchiato, cappuccino and other speciality coffees with milk



Your JURA prepares latte macchiato, cappuccino, flat white and espresso macchiato at the touch of a button. There is no need to move the glass or cup.

Example: Proceed as follows to prepare one latte macchiato.

- ▶ Place a glass under the cappuccino frother.
 - ▶ Turn the setting wheel of the cappuccino frother to the Milk Foam area .
 - ▶ Press the 'Latte macchiato' button.
- 'Latte macchiato' appears and the preset amount of milk flows into the glass.

i There is a short interval while the hot milk separates from the milk foam. This allows the typical layers of a latte macchiato to form.

Coffee preparation starts. The preset amount of water for espresso flows into the glass. Preparation stops automatically. 'Rinse the milk system' appears on the display.

i 15 minutes after preparation, the milk system is automatically rinsed (see Chapter 5 'Maintenance – Automatic milk system rinsing'). Therefore always place a receptacle under the cappuccino frother after preparing milk.

To ensure that the cappuccino frother always works properly, you must clean it **daily** when you have been preparing milk (see Chapter 5 'Maintenance – Cleaning the milk system').

Ground coffee

You can choose to use a second coffee variety, for example decaffeinated coffee, with the filter funnel for ground coffee.

- i** Never add more than two level measuring spoons of ground coffee.
- i** Use ground coffee which is not ground too finely. Very fine coffee can block up the system so that the coffee only comes out in drips.
- i** If you did not fill the machine with a sufficient amount of ground coffee, 'Not enough ground coffee' is displayed and the JURA stops the operation.

2 Preparation

- i** The desired speciality coffee must be prepared within approximately one minute after filling with the ground coffee. Otherwise the JURA stops the operation and is once more ready for use.

All speciality coffees with ground coffee are always prepared following the same model.

Example: Proceed as follows to prepare one espresso using ground coffee.



- ▶ Place an espresso cup under the coffee spout.
- ▶ Open the powder chute cover.
'Please add ground coffee'
- ▶ Place one level measuring spoon of ground coffee into the filler funnel.
- ▶ Close the cover of the filler funnel.
'Please select product'
- ▶ Press the **'Espresso'** button.
Preparation starts. **'Espresso'** appears and the preset amount of water for espresso flows into the cup.
Preparation stops automatically. Your JURA is once more ready for use.

Permanently setting the amount of water for the cup size

It is easy to permanently adjust the amount of water for all **single products** to the cup size. Adjust the amount once as shown in the following example. Every time you prepare a drink in the future, this amount will be dispensed.

Example: Proceed as follows to **permanently** set the amount of water for one coffee.



- ▶ Place a cup under the coffee spout.
- ▶ Press and **hold** the **'Coffee'** button until **'Enough coffee? Press button'** appears.
- ▶ Release the **'Coffee'** button.
Preparation starts and the coffee flows into the cup.
- ▶ Press any button as soon as there is sufficient coffee in the cup.
Preparation stops. **'Saved'** appears briefly on the display. The set amount of water for one coffee is permanently stored. Your JURA is once more ready for use.

- i** You can alter this setting at any time by repeating the above procedure.
- i** You can also permanently set the amounts for all single products in programming mode (see Chapter 4 'Permanent settings in programming mode – Adjusting the product settings').

Adjusting the grinder

You can adjust the grinder to suit the degree of roast of your coffee.

CAUTION

If you adjust the consistency of grind when the grinder is not operating, the grinder adjustment switch could be damaged.

- ▶ Only adjust the consistency of grind when the grinder is running.

The consistency of grind is correct if the coffee flows regularly from the coffee spout. In addition a fine, thick crema forms.

Example: Proceed as follows to change the consistency of grind **during** the preparation of an espresso.

- ▶ Place a cup under the coffee spout.
- ▶ Open the storage compartment cover.
- ▶ Press the '**Espresso**' button to start preparation.
- ▶ Turn the grinder adjustment switch to the desired position **while** the grinder is running.

The preset amount of water flows into the cup. Preparation stops automatically.

- ▶ Close the storage compartment cover.



Hot water

⚠ CAUTION

There is a danger of scalding from hot water splashes.

- ▶ Avoid direct contact with the skin.



- ▶ Place a cup under the hot-water spout.
- ▶ Press the '**Hot water**' button.
'Hot water', the preset amount of water flows into the cup. Preparation stops automatically. 'Please select product' appears on the display.

3 Daily operation

Filling the water tank

Daily maintenance of the machine and hygiene when handling milk, coffee and water are key to a perfect coffee result in the cup every time. You should therefore change the water **daily**.

CAUTION

Milk, sparkling mineral water or other liquids can damage the water tank or the machine.

- ▶ Only fill the water tank with fresh, cold water.

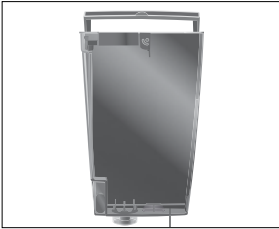

- ▶ Open the water tank cover.
- ▶ Remove the water tank and rinse it with cold water.
- ▶ Fill the water tank with fresh, cold water and reinsert the tank.
- ▶ Close the water tank cover.

Switching on the machine

Daily maintenance of the machine and hygiene when handling milk, coffee and water are key to a perfect coffee result in the cup every time. You should therefore change the water **daily**.



- ▶ Place a receptacle under the coffee spout.
- ▶ Press the On/Off button  to switch the JURA on.

‘Welcome to JURA’

‘Machine is heating’

‘Machine is rinsing’, the system is rinsed.

The rinse stops automatically. ‘Please select product’ appears on the display. Your JURA is ready for use.

Daily maintenance

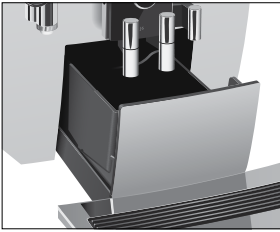

To ensure that you get many years of reliable service out of your JURA and to guarantee the optimum coffee quality, the machine requires daily maintenance.

- ▶ Pull out the drip tray.
 - ▶ Empty the coffee grounds container and the drip tray. Rinse them both with warm water.
- i** Always empty the coffee grounds container when the machine is **switched on**. This is the only way of resetting the coffee grounds counter.
- ▶ Refit the coffee grounds container and the drip tray.
 - ▶ Rinse the water tank with clean water.
 - ▶ Clean the cappuccino frother (see Chapter 5 'Maintenance – Cleaning the milk system').
 - ▶ Remove the milk pipe and rinse it thoroughly under running water.
 - ▶ Dismantle and rinse the cappuccino frother (see Chapter 5 'Maintenance – Dismantling and rinsing the cappuccino frother').
 - ▶ Wipe the surface of the machine with a clean, soft, damp cloth (e.g. microfibre cloth).

Regular maintenance

Carry out the following maintenance actions **regularly** or **as required**:

- In the interests of hygiene, we recommend changing the milk pipe and interchangeable milk spout on a regular basis (approximately every 3 months). Replacements are available from specialised dealers.
- Clean the inside of the water tank, e.g. with a brush. Further information about the water tank is provided in these instructions for use (see Chapter 5 'Maintenance – Descaling the water tank').
- Traces of milk and coffee may stick to the top and bottom of the cup grille. If this happens, clean the cup grille.

Switching off the machine



When the JURA is switched off, the system is automatically rinsed if a speciality coffee has been prepared. If milk has been prepared, you will also be prompted to clean the milk system.

- ▶ Place one receptacle under the coffee spout and another under the cappuccino frother.
- ▶ Press the On/Off button .

i If milk has been prepared, you will be prompted to clean the milk system ('**Clean the milk system**'). After 10 seconds the switch-off process continues automatically.

If milk has been prepared but you have not started milk system cleaning, the milk system is rinsed first ('**Milk system is being rinsed**').

'**Machine is rinsing**', the system rinses itself. The operation stops automatically. Your JURA is switched off.

4 Permanent settings in programming mode

Press the P button to enter programming mode. You can navigate through the programme items and permanently save the required settings simply by turning the Rotary Switch and using the multi-function buttons. The following settings can be made:

Programme item	Sub-item	Explanation
'Maintenance status'	'Clean',	▶ Here you can start the required maintenance programme or find out what maintenance actions are required.
	'Change the filter' (only if filter is fitted),	
	'Descalc',	
	'Clean the milk system',	
	'Rinse',	
	'Maintenance information'	
'Product settings'	'Expert mode'	▶ Select your settings for speciality coffees and hot water.
	'Classics'	▶ Replace the products on the start screen and in the product selector with your favourites. Duplicate and personalise your favourite speciality coffees by giving them a new product name and individual settings.
'Machine settings'	'Choose language'	▶ Select your language.
	'Switch off after'	▶ Set the time after which the JURA should switch off automatically.
	'Save energy'	▶ Select an energy-saving mode.
	'Factory setting'	▶ Reset the machine to its factory setting.
	'Units'	▶ Select the unit for the amount of water.
	'Display'	▶ Change the display settings.
	'Water hardness'	▶ Adjust the water hardness.
	'Product counter', 'Maintenance counter'	▶ Keep track of all products prepared and view the number of maintenance programmes performed.
	'Version'	Software version
	'Connect accessory', 'Disconnect accessories'	▶ Connect the machine wirelessly to a JURA accessory or disconnect the connection again. (Only displayed if the JURA Smart Connect is being used.)

Adjusting the product settings

In the programme item ‘**Product settings**’ / ‘**Expert mode**’ you can make individual settings for all speciality coffees and hot water. The following permanent settings can be made:

Product	Coffee strength	Amount	More settings
Ristretto, espresso	10 levels	Coffee: 15 ml – 80 ml	Temperature (low, normal, high), Product name
Coffee	10 levels	Coffee: 25 ml – 240 ml	Temperature (low, normal, high), Product name
Two ristretti, two espressi, two coffees	–	Coffee: the amount set for the single product is doubled.	Temperature (as for single product), Product name
Latte macchiato	10 levels	Coffee: 25 ml – 240 ml Milk: 0 sec. – 120 sec. Interval: 0 sec. – 60 sec.	Temperature (low, normal, high), Product name
Cappuccino, flat white	10 levels	Coffee: 25 ml – 240 ml Milk: 0 sec. – 120 sec.	Temperature (low, normal, high), Product name
Espresso macchiato	10 levels	Coffee: 15 ml – 80 ml Milk: 0 sec. – 120 sec. Interval: 0 sec. – 60 sec.	Temperature (low, normal, high), Product name
Portion of milk	–	Milk: 0 sec. – 120 sec.	Product name
Hot water	–	Water: 25 ml – 450 ml	Temperature (low, normal, high), Product name

Permanent settings in programming mode always follow the same model.

Example: Proceed as follows to change the amount of water and coffee strength for one espresso.

- ▶ Press the P button.
‘**Maintenance status**’
- ▶ Turn the Rotary Switch until ‘**Product settings**’ is displayed.
- ▶ Press the Rotary Switch.
‘**Expert mode**’
- ▶ Press the Rotary Switch to enter the programme item.
‘**Expert mode**’
- ▶ Press the ‘**Espresso**’ button.
‘**Expert mode**’ / ‘**Espresso**’
- ▶ Press the Rotary Switch.
‘**Espresso**’
- ▶ Press the Rotary Switch.

- ▶ Turn the Rotary Switch to change the coffee strength setting.
- ▶ Press the Rotary Switch to confirm the setting.
- ▶ Turn the Rotary Switch until the fill volume is in focus.
- ▶ Press the Rotary Switch.
- ▶ Turn the Rotary Switch to change the fill volume setting.
- ▶ Press the Rotary Switch to confirm the setting.
- ▶ Press the 'Save' button.
- ▶ 'Saved' appears briefly on the display.
- ▶ 'Expert mode' / 'Espresso'
- ▶ Press the P button to exit programming mode.

Adding products to the start screen, duplicating and personalising

In the programme item 'Product settings' / 'Classics' you will find all the products stored as standard in your JURA. You can move any of these products to your preferred position on the start screen or in the product selector and make it one of your favourites. **You can duplicate** and **personalise** your favourite speciality coffees by giving them a new product name and individual settings (e.g. amount and coffee strength).

Example: Proceed as follows to replace 'Latte macchiato' on the start screen with 'Macchiato'.

- ▶ Press the P button.
- ▶ 'Maintenance status'
- ▶ Turn the Rotary Switch until 'Product settings' is displayed.
- ▶ Press the Rotary Switch.
- ▶ 'Expert mode'
- ▶ Turn the Rotary Switch until 'Classics' is displayed.
- ▶ Press the Rotary Switch to enter the programme item.
- ▶ 'Add to favourites'
- ▶ Press the Rotary Switch again.
- ▶ Turn the Rotary Switch until 'Macchiato' is in focus.
- ▶ Press the Rotary Switch.
- ▶ 'Select position'
- ▶ Press the 'Latte macchiato' button.
- ▶ 'Macchiato' / 'Do you want to replace the current product?'
- ▶ Press the 'Yes' button.
- ▶ 'Saved' appears briefly on the display.
- ▶ 'Product name'

4 Permanent settings in programming mode

- i** You can now give the product you just added a new name.
 - ▶ Press the 'Save' button.
'Macchiato'
- i** You can now change various settings for the product. To do this, briefly press the Rotary Switch to access the various setting options. Confirm the settings by pressing the 'Save' button.
- i** If you do not want to change any more settings, just press the '⏪' button.
 - ▶ Press the P button to exit programming mode.

Automatic switch-off

By instructing your JURA to automatically switch itself off, you can cut down your energy consumption. If this function is activated, your JURA switches off automatically after the preset time following the last action on the machine.

You can set the automatic switch-off to 15 minutes, 30 minutes or 1-9 hours.

- ▶ Press the P button.
'Maintenance status'
- ▶ Turn the Rotary Switch until 'Machine settings' is displayed.
- ▶ Press the Rotary Switch.
'Choose language'
- ▶ Turn the Rotary Switch until 'Switch off after' is displayed.
- ▶ Press the Rotary Switch to enter the programme item.
'Switch off after'
- ▶ Turn the Rotary Switch to change the switch-off time.
- ▶ Press the 'Save' button.
'Saved' appears briefly on the display.
'Switch off after'
- ▶ Press the P button to exit programming mode.

Energy-saving mode

In the programme item 'Machine settings' / 'Save energy' you can permanently set an energy-saving mode (Energy Save Mode, E.S.M.®):

- 'Active'
 - Soon after the last preparation, the JURA stops heating up. After about 5 minutes the message 'Energy Save' is displayed.
 - Before you can prepare a speciality coffee, speciality coffee with milk, or hot water, the machine must heat up.
- 'Inactive'
 - All speciality coffees, speciality coffees with milk and hot water can be prepared without having to wait.

Example: Proceed as follows to change the energy-saving mode from 'Active' to 'Inactive'.

- ▶ Press the P button.
'Maintenance status'
- ▶ Turn the Rotary Switch until 'Machine settings' is displayed.
- ▶ Press the Rotary Switch.
'Choose language'
- ▶ Turn the Rotary Switch until 'Save energy' is displayed.
- ▶ Press the Rotary Switch to enter the programme item.
'Save energy'
- ▶ Turn the Rotary Switch until 'Inactive' is displayed.
- ▶ Press the 'Save' button.
'Saved' appears briefly on the display.
'Save energy'
- ▶ Press the P button to exit programming mode.

Setting the water hardness

The harder the water is, the more frequently the JURA needs to be descaled. It is therefore important to set the water hardness accurately.

The water hardness was set when the machine was first used. You can change this setting at any time.

The water hardness can be adjusted on a continuous scale between 1 °dH and 30 °dH.

- ▶ Press the P button.
'Maintenance status'

4 Permanent settings in programming mode

- ▶ Turn the Rotary Switch until **'Machine settings'** is displayed.
- ▶ Press the Rotary Switch.
'Choose language'
- ▶ Turn the Rotary Switch until **'Water hardness'** is displayed.
- ▶ Press the Rotary Switch to enter the programme item.
'Water hardness'
- ▶ Turn the Rotary Switch to change the setting.
- ▶ Press the **'Save'** button.
'Saved' appears briefly on the display.
'Water hardness'
- ▶ Press the P button to exit programming mode.

Display settings

In the programme item **'Machine settings'** / **'Display'** you can set the display brightness (as a percentage).

- ▶ Press the P button.
'Maintenance status'
- ▶ Turn the Rotary Switch until **'Machine settings'** is displayed.
- ▶ Press the Rotary Switch.
'Choose language'
- ▶ Turn the Rotary Switch until **'Display'** is displayed.
- ▶ Press the Rotary Switch to enter the programme item.
'Display'
- ▶ Turn the Rotary Switch to change the setting.
- ▶ Press the **'Save'** button.
'Saved' appears briefly on the display.
'Display'
- ▶ Press the P button to exit programming mode.

Unit for amount of water

In the programme item **'Machine settings'** / **'Units'** you can select the unit used for the amount of water.

Example: Proceed as follows to change the unit for the amount of water from **'ml'** to **'oz'**.

- ▶ Press the P button.
'Maintenance status'
- ▶ Turn the Rotary Switch until **'Machine settings'** is displayed.
- ▶ Press the Rotary Switch.
'Choose language'
- ▶ Turn the Rotary Switch until **'Units'** is displayed.

- ▶ Press the Rotary Switch to enter the programme item.
‘Units’
- ▶ Turn the Rotary Switch until ‘oz’ is displayed.
- ▶ Press the ‘Save’ button.
‘Saved’ appears briefly on the display.
‘Units’
- ▶ Press the P button to exit programming mode.

Restore factory settings

In the programme item ‘Machine settings’ / ‘Factory setting’ the machine can be reset to its factory setting: **All user settings** (apart from the ‘filter’ and ‘water hardness’) are reset to factory settings. Your JURA then switches off.

- ▶ Press the P button.
‘Maintenance status’
- ▶ Turn the Rotary Switch until ‘Machine settings’ is displayed.
- ▶ Press the Rotary Switch.
‘Choose language’
- ▶ Turn the Rotary Switch until ‘Factory setting’ is displayed.
- ▶ Press the Rotary Switch to enter the programme item.
‘Factory setting’ / ‘Reset the machine to the factory settings?’
- ▶ Press the ‘Yes’ button.
‘Saved’ appears briefly on the display.
Your JURA is switched off.

Language

In this programme item you can set the language used by your JURA.

Example: Proceed as follows to change the language from ‘English’ to ‘Deutsch’.

- ▶ Press the P button.
‘Maintenance status’
- ▶ Turn the Rotary Switch until ‘Machine settings’ is displayed.
- ▶ Press the Rotary Switch.
‘Choose language’
- ▶ Press the Rotary Switch to enter the programme item.
‘Choose language’
- ▶ Turn the Rotary Switch until ‘Deutsch’ is displayed.

- ▶ Press the 'Save' button.
'Gespeichert' appears briefly on the display.
'Sprachauswahl'
- ▶ Press the P button to exit programming mode.
'Bitte wählen'

Querying information

In the programme item 'Machine settings' you can view the following information:

- 'Product counter': Number of prepared speciality coffees, milk and hot water
- 'Maintenance counter': Number of maintenance programmes performed (cleaning, descaling etc.)
- 'Version': Software version

Example: Proceed as follows to view the number of speciality coffees prepared.

- ▶ Press the P button.
'Maintenance status'
 - ▶ Turn the Rotary Switch until 'Machine settings' is displayed.
 - ▶ Press the Rotary Switch.
'Choose language'
 - ▶ Turn the Rotary Switch until 'Product counter' is displayed.
 - ▶ Press the Rotary Switch to enter the programme item.
'Product counter'
- i** Turn the Rotary Switch to view the number of other speciality coffees.
- ▶ Press the P button to exit programming mode.

5 Maintenance

Your JURA has the following integrated maintenance programmes:

- Rinsing the machine
- Rinsing the milk system in the dual spout
- Cleaning the milk system in the dual spout ('Clean the milk system')
- Changing the filter ('Change the filter')
(only if filter is activated)
- Cleaning the machine ('Clean')
- Descaling the machine ('Descale')
(only if filter is not activated)

- i** Clean or descale the machine, rinse the milk system or change the filter when you are prompted to do so.
- i** Press the P button to view a list of the maintenance programmes ('Maintenance status'). When the bar is completely filled with red, your JURA will prompt you to perform the appropriate maintenance programme.
- i** In the interests of hygiene, you should clean the milk system **daily** when you have been preparing milk.

Rinsing the machine



You can initiate the rinse operation manually at any time.

- ▶ Place a receptacle under the coffee spout.
 - ▶ Press the P button.
'Maintenance status'
 - ▶ Press the Rotary Switch.
'Clean'
 - ▶ Turn the Rotary Switch until 'Rinse' is displayed.
 - ▶ Press the Rotary Switch to initiate the rinse operation.
'Machine is rinsing', 'Milk system is being rinsed', water flows out of the coffee spout.
- The rinse stops automatically. 'Please select product' appears on the display.

Automatic milk system rinsing

15 minutes after milk preparation, the milk system is **automatically** rinsed. Therefore always place a receptacle under the cappuccino frother after preparing milk.

When **'Rinse the milk system'** is displayed, you can start rinsing by pressing the Rotary Switch.

Cleaning the milk system

To ensure that the cappuccino frother always works properly, you must clean it **daily** when you have been preparing milk.

CAUTION

If the wrong cleaning agent is used, the machine could be damaged and/or traces could be left behind in the water.

- ▶ Use only original JURA maintenance products.

- i** JURA milk system cleaner is available from specialised dealers.
- i** To clean the milk system, use the container supplied.

- ▶ Press the P button.
'Maintenance status'
- ▶ Press the Rotary Switch.
'Clean'
- ▶ Turn the Rotary Switch until **'Clean the milk system'** is displayed.
- ▶ Press the Rotary Switch.
'Clean the milk system'
- ▶ Press the Rotary Switch again.
- ▶ Press the **'Start'** button.
- ▶ Remove the milk pipe from the milk container or carton.
- ▶ Add 1 dosing unit of milk system cleaner to the front part of the container.
- ▶ Then fill with warm water up to the **upper mark**.
- ▶ Place the container under the cappuccino frother.
- ▶ Turn the setting wheel of the cappuccino frother to the Milk position **☐**.



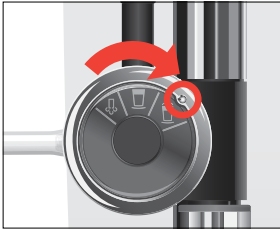
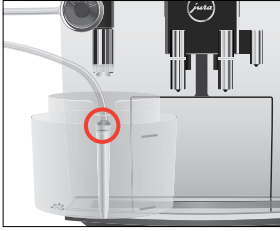

- ▶ Connect the milk pipe to the container.

i To connect the milk pipe to the container correctly, the pipe must be fitted with a connector.

- ▶ Press the 'Next' button.

'Milk system is being cleaned' appears and the cappuccino frother and the milk pipe are cleaned.

- ▶ During the first brief interruption, set the setting wheel of the cappuccino frother to the Milk Foam position .

'Water for cleaning milk system'

- ▶ Rinse the container thoroughly and fill the front part with fresh water up to the **upper mark**.
 - ▶ Place this under the cappuccino frother and reconnect the milk pipe to the container.
 - ▶ Press the 'Next' button.
- 'Milk system is being cleaned' appears and the cappuccino frother and the milk pipe are rinsed with fresh water. The start screen is displayed.

Dismantling and rinsing the cappuccino frother

To make sure the cappuccino frother works properly, and in the interests of hygiene, it must be dismantled and rinsed **daily** if you have been preparing milk.

- ▶ Remove the milk pipe and rinse it thoroughly under running water.
- ▶ Carefully pull the cappuccino frother down and off.
- ▶ Dismantle the cappuccino frother into its individual parts.
- ▶ Rinse all the parts under running water. If there are severely dried-on milk residues, firstly immerse the individual parts in a solution of 250 ml warm water and 1 capful of JURA milk system cleaner. Then rinse the parts thoroughly.
- ▶ Reassemble the cappuccino frother.

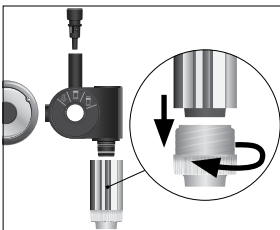

i Ensure that all individual parts are correctly and firmly connected to ensure correct operation of the cappuccino frother.

- ▶ Firmly attach the frother to the connector.

Inserting the filter



Your JURA no longer has to be descaled if you are using the CLARIS Smart filter cartridge. If you did not insert the filter cartridge the first time you used the machine, you can do this now as follows.

- ▶ Place a receptacle under the hot-water spout.
- ▶ Remove and empty the water tank.
- ▶ Open the filter holder.
- ▶ Fit the filter cartridge extension supplied on top of a CLARIS Smart filter cartridge.

- ▶ Insert the filter cartridge with its extension into the water tank.
- ▶ Close the filter holder. It will click into place audibly.
- ▶ Fill the water tank with fresh, cold water and reinsert the tank.

i The machine automatically detects that you have just inserted the filter cartridge.

‘Filter operation’ / ‘Saved’

‘Filter is being rinsed’, water flows out of the hot-water spout.

Rinsing of the filter stops automatically after approximately 300 ml.

‘Empty drip tray’

- ▶ Empty the drip tray and put it back into the machine.

‘Filter operation’ / ‘Filter rinsing complete’

‘Please select product’ appears on the display. Your JURA is once more ready for use.

Changing the filter

i Once the filter cartridge stops working (depending on the water hardness setting), the JURA will prompt you to change the filter.

i CLARIS Smart filter cartridges are available from specialised dealers.

Precondition: ‘Change filter’ is displayed.



- ▶ Place a receptacle under the hot-water spout.
- ▶ Remove and empty the water tank.
- ▶ Open the filter holder and remove the old CLARIS Smart filter cartridge and filter extension.
- ▶ Fit the filter cartridge extension on top of a **new** CLARIS filter cartridge Smart.

- ▶ Insert the filter cartridge with its extension into the water tank.
- ▶ Close the filter holder. It will click into place audibly.
- ▶ Fill the water tank with fresh, cold water and reinsert the tank.

i The machine automatically detects that you have just changed the filter cartridge.

‘Change the filter’ / ‘Saved’

‘Filter is being rinsed’, water flows out of the hot-water spout.

‘Empty drip tray’

- ▶ Empty the drip tray and put it back into the machine.

‘Change the filter’ / ‘Filter rinsing complete’

‘Please select product’ appears on the display. Your JURA is once more ready for use.

Cleaning the machine

After 180 preparations or 80 switch-on rinses, the JURA will prompt you to clean it.

CAUTION If the wrong cleaning agent is used, the machine could be damaged and/or traces could be left behind in the water.

- ▶ Use only original JURA maintenance products.

i The cleaning programme lasts approximately 20 minutes.

i Do not interrupt the cleaning programme. The quality of cleaning will be impaired if you do so.

i JURA cleaning tablets are available from specialised dealers.

Precondition: ‘Clean machine’ is displayed.

- ▶ Press the P button.

‘Clean’

- ▶ Press the Rotary Switch.
- ▶ Press the 'Start' button.
- ▶ Press the 'Start' button again.
'Empty coffee grounds container'
- ▶ Empty the drip tray and coffee grounds container and put them back into the machine.
'Press the Rotary Switch'
- ▶ Place one receptacle under the coffee spout and another under the cappuccino frother.
- ▶ Press the Rotary Switch.
'Machine is being cleaned', water flows out of the coffee spout.
The operation is interrupted, 'Add cleaning tablet'.
- ▶ Open the cover of the filler funnel for ground coffee.
- ▶ Insert a JURA cleaning tablet into the filler funnel.
- ▶ Close the cover of the filler funnel.
'Press the Rotary Switch'
- ▶ Press the Rotary Switch.
'Machine is being cleaned', water flows repeatedly out of the coffee spout and the cappuccino frother.
The operation stops automatically.
'Empty coffee grounds container'
- ▶ Empty the drip tray and coffee grounds container and put them back into the machine.
Cleaning is now complete. The start screen is displayed.



Descaling the machine

The JURA builds up deposits of limescale over time and automatically prompts you to descale it when necessary. The degree of calcification depends on the hardness of your water.

i If you are using a CLARIS Smart filter cartridge, you will not be prompted to descale.

⚠ CAUTION

If the descaling agent comes into contact with the skin or eyes, this can cause irritation.

- ▶ Avoid contact with the skin or eyes.
- ▶ Rinse off the descaling agent with clean water. Should you get any descaling agent in your eye, see a doctor.

CAUTION If the wrong descaling agent is used, the machine could be damaged and/or traces could be left behind in the water.

- ▶ Use only original JURA maintenance products.

CAUTION If the descaling operation is interrupted, there may be damage to the machine.

- ▶ Allow the descaling programme to run to the end.

CAUTION If the descaling agent comes into contact with sensitive surfaces (e.g. marble), damage cannot be ruled out.

- ▶ Clean up any splashes immediately.

- i** The descaling programme lasts approximately 45 minutes.
- i** JURA descaling tablets are available from specialised dealers.

Precondition: 'Decalcify machine' is displayed.

- ▶ Press the P button.
- 'Descale'
- ▶ Press the Rotary Switch.
- ▶ Press the 'Start' button.
- ▶ Press the 'Start' button again.
- 'Empty drip tray'
- ▶ Empty the drip tray and coffee grounds container and put them back into the machine.
- 'Pour descaling agent into water tank'
- ▶ Remove and empty the water tank.
- ▶ Completely dissolve 3 JURA descaling tablets in a receptacle holding 500 ml of water. This may take several minutes.
- ▶ Pour the solution into the **empty** water tank and insert it into the machine.

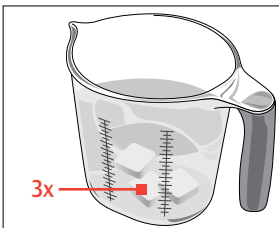

- ▶ Place one receptacle under the hot-water spout and another under the cappuccino frother.
- 'Press the Rotary Switch'
- ▶ Press the Rotary Switch.
- 'Machine is being descaled' appears and water flows repeatedly out of the hot-water spout and the cappuccino frother. The operation is interrupted, 'Empty drip tray'.



- ▶ Empty the drip tray and coffee grounds container and put them back into the machine.

‘Fill water tank’

- ▶ Remove the water tank and rinse it thoroughly.
- ▶ Fill the water tank with fresh, cold water and reinsert the tank.

‘Press the Rotary Switch’

- ▶ Place a receptacle under the cappuccino frother, the coffee spout and the hot-water spout.
- ▶ Press the Rotary Switch.

‘Machine is being descaled’, the descaling operation is continued.

The operation is interrupted, ‘Empty drip tray’.

- ▶ Empty the drip tray and coffee grounds container and put them back into the machine.

Descaling is now complete. The start screen is displayed.

- i** If the descaling operation stops unexpectedly, rinse the water tank thoroughly.

Cleaning the bean container

Coffee beans may be covered with a slight oil film which remains on the walls of the bean container. These traces may negatively affect the coffee result. For this reason clean the bean container from time to time.

Precondition: ‘Fill bean container’ is displayed.

- ▶ Switch the machine off with the On/Off button .
- ▶ Open the bean container cover and remove the aroma preservation cover.
- ▶ Clean the bean container with a soft, dry cloth.
- ▶ Fill the bean container with coffee beans, then close the aroma preservation cover and the bean container cover.

Descaling the water tank

Limescale deposits may form in the water tank. To ensure correct function of the machine, descale the water tank from time to time.

- ▶ Remove the water tank.
- ▶ If you use a CLARIS Smart filter cartridge, remove this.
- ▶ Completely fill the water tank and dissolve 3 JURA descaling tablets in it.
- ▶ Leave the water tank with the descaling solution for several hours (e.g. overnight).
- ▶ Empty the water tank and rinse it thoroughly.
- ▶ If you use a CLARIS Smart filter cartridge, insert this again.
- ▶ Fill the water tank with fresh, cold water and reinsert the tank.

6 Display messages

Message	Cause/Result	Action
'Fill water tank'	The water tank is empty. You cannot prepare any products.	▶ Fill the water tank (see Chapter 3 'Daily operation – Filling the water tank').
'Empty coffee grounds container'	The coffee grounds container is full. You cannot prepare any products.	▶ Empty the coffee grounds container and the drip tray (see Chapter 3 'Daily operation – Daily maintenance').
'Drip tray not fitted'	The drip tray is not inserted correctly or is not inserted at all. You cannot prepare any products.	▶ Fit the drip tray.
'Fill bean container'	The bean container is empty. You cannot prepare any speciality coffees, but you can prepare hot water and milk.	▶ Fill the bean container (see Chapter 1 'Preparing and using for the first time – Filling the bean container').
'Rinse the milk system'	The JURA requests a milk system rinse.	▶ Press the Rotary Switch to start rinsing or wait 15 minutes until rinsing starts automatically (see Chapter 5 'Maintenance – Automatic milk system rinsing').
'Change filter'	The filter cartridge no longer works. The JURA is prompting a filter change.	▶ Replace the CLARIS Smart filter cartridge (see Chapter 5 'Maintenance – Changing the filter').
'Clean machine'	The JURA is prompting you to clean it.	▶ Perform cleaning (see Chapter 5 'Maintenance – Cleaning the machine').
'Decalcify machine'	The JURA is prompting you to descale it.	▶ Perform descaling (see Chapter 5 'Maintenance – Descaling the machine').
'Not enough ground coffee'	There is insufficient ground coffee in the machine; the JURA stops the operation.	▶ The next time you prepare a beverage, add more ground coffee (see Chapter 2 'Preparation – Ground coffee').
'Machine too hot for maintenance'	The system is too hot to start a maintenance programme.	▶ Wait for several minutes until the system has cooled or prepare a speciality coffee or hot water.

7 Troubleshooting

Problem	Cause/Result	Action
Insufficient foam is produced when the milk is frothed or milk sprays from the cappuccino frother.	The cappuccino frother is dirty.	<ul style="list-style-type: none"> ▶ Clean the cappuccino frother (see Chapter 5 'Maintenance – Cleaning the milk system'). ▶ Dismantle and rinse the cappuccino frother (see Chapter 5 'Maintenance – Dismantling and rinsing the cappuccino frother').
Coffee only comes out in drips when it is being prepared.	The coffee is ground too finely and obstructs the system. The water hardness may not have been correctly set.	<ul style="list-style-type: none"> ▶ Set the grinder to a coarser setting (see Chapter 2 'Preparation – Adjusting the grinder'). ▶ Perform descaling (see Chapter 5 'Maintenance – Descaling the machine ').
'Fill water tank' is displayed although the water tank is full.	The water tank float is trapped.	<ul style="list-style-type: none"> ▶ Descale the water tank (see Chapter 5 'Maintenance – Descaling the water tank').
Little or no water or steam comes out of the cappuccino frother. The pump is very quiet.	The connector of the cappuccino frother may be blocked by milk residues or limescale fragments loosened during descaling.	<ul style="list-style-type: none"> ▶ Remove the cappuccino frother. ▶ Unscrew the black connector with the aid of the hexagonal hole on the measuring spoon for ground coffee. ▶ Clean the connector thoroughly. ▶ Screw the connector back on by hand. ▶ Carefully tighten it using the hexagonal hole on the measuring spoon, turning by no more than a quarter of a rotation.
Grinder is making a very loud noise.	There are foreign objects in the grinder.	<ul style="list-style-type: none"> ▶ Contact customer support in your country (see Chapter 11 'JURA contact details / Legal information').
'Error 2' or 'Error 5' is displayed.	If the machine has been exposed to the cold for a long period of time, heating may be disabled for safety reasons.	<ul style="list-style-type: none"> ▶ Warm the machine at room temperature.

7 Troubleshooting

Problem	Cause/Result	Action
Other 'Error' messages are displayed.	-	▶ Switch the JURA off with the On/Off button  . Contact customer support in your country (see Chapter 11 'JURA contact details / Legal information').

- i** If you were unable to solve the problem, contact customer support in your country (see Chapter 11 'JURA contact details / Legal information').

8 Transport and environmentally friendly disposal

Transport / Emptying the system

Keep the packaging for your JURA. It should be used to protect the machine during transport.

In order to protect the JURA from frost during transport, the system must be emptied.



- ▶ Remove the milk pipe from the cappuccino frother.
- ▶ Place a receptacle under the cappuccino frother.
- ▶ Turn the Rotary Switch until '1 portion milk' is in focus.
- ▶ Press the Rotary Switch.
'1 portion milk' appears and hot steam is discharged from the cappuccino frother.
- ▶ Remove and empty the water tank.
- ▶ Turn the Rotary Switch until '60 sec.' is displayed.
Steam will continue to be discharged from the cappuccino frother until the system is empty.
'Fill water tank'
- ▶ Press the On/Off button .
Your JURA is switched off.

Disposal

Please dispose of old machines in an environmentally neutral way.



Old machines contain valuable, recyclable materials which should be recycled. Please therefore dispose of old machines via suitable collection systems.

9 Technical data

Voltage	220–240 V ~, 50 Hz
Power	1450 W
Conformity mark	CE
Energy consumption 'Save energy' / 'Active'	approx. 6 Wh
Energy consumption 'Save energy' / 'Inactive'	approx. 11 Wh
Pump pressure	static, max. 15 bar
Holding capacity of water tank	2.1 l
Holding capacity of bean container	250 g
Holding capacity of coffee grounds container	max. 16 portions
Cable length	approx. 1.1 m
Weight	10.7 kg
Dimensions (W × H × D)	28.5 × 34.2 × 43.3 cm

Wireless connections:

CLARIS Smart filter cartridge (RFID technology)	Frequency band 13.56 MHz Max. transmission power < 1 mW
JURA Smart Connect (Bluetooth connection)	Frequency band 2.4 GHz Max. transmission power < 1 mW

10 Index

A

- Adding products to the start screen 25
- Addresses 48
- Adjusting the product settings 24
- Aroma preservation cover
 - Bean container with aroma preservation cover 4
- Automatic switch-off 26

B

- Bean container
 - Bean container with aroma preservation cover 4
 - Cleaning 38
 - Filling 10
- Bluetooth 44
- Bus bar
 - Technical data 44
- Button
 - On/Off button 5
 - P button (programming) 5

C

- Caffè latte 17
- Cappuccino 17
- Cappuccino frother cleaning
 - Cleaning the milk system 32
- Changing the product assigned to a button 25
- CLARIS Smart filter cartridge
 - Change 34
 - Insert 34
- Cleaning
 - Bean container 38
 - Machine 35
- Coffee 16
 - Two coffees 16
- Coffee grounds container 4
- Coffee spout
 - Height- and width-adjustable coffee spout 4
- Connect accessory 14
- Consistency of grind
 - Adjusting the grinder 19
 - Grinder adjustment switch 4

- Contact details 48
- Cover
 - Bean container 4
 - Filler funnel for ground coffee 4
 - Storage compartment 4
 - Water tank 4
- Cup grille 4
- Customer support 48

D

- Daily maintenance 21
- Declaration of Conformity 48
- Descaling
 - Machine 36
 - Water tank 39
- Dismantling
 - Cappuccino frother 33
- Dismantling and rinsing
 - the cappuccino frother 33
- Display 5
- Display messages 40
- Display settings 28
- Disposal 43
- Double product 16
- Drip tray 4

E

- Emptying the system 43
- Energy-saving mode 27
- Errors
 - Troubleshooting 41
- Espresso 16
 - Two espressi 16
- Espresso macchiato 17
- EU Declaration of Conformity 48

F

- Factory settings
 - Restore factory settings 29
- Filler funnel
 - Filler funnel for ground coffee 4
- Filling
 - Bean container 10
 - Water tank 20
- Filter
 - Change 34
 - Insert 34

10 Index

- First-time use 11
 - With filter cartridge activation 12
 - Without filter cartridge activation 13
- Flat white 17
- Frother
 - Cappuccino frother 4

G

- Grinder adjustment switch 4
- Ground coffee 17
 - Measuring spoon for ground coffee 4

H

- Homepage 10
- Hotline 48
- Hot water 19
- Hot-water spout 4

I

- Instant coffee
 - Ground coffee 17
- Interchangeable milk spout 4
- Internet 10

J

- JURA
 - Contact details 48
 - Internet 10

L

- Language 29
- Latte macchiato 17

M

- Machine
 - Cleaning 35
 - Daily maintenance 21
 - Descaling 36
 - Regular maintenance 21
 - Rinsing 31
 - Setting up 10
 - Switching off 22
 - Switching on 20
- Mains cable 4
- Maintenance 31
 - Daily maintenance 21
 - Regular maintenance 21
- Measuring spoon for ground coffee 4
- Messages, display 40

Milk

- Connecting milk 14
- Milk spout 4
- Milk system
 - Cleaning 32
- Milk system rinsing 32

P

- Permanently setting the water for the cup size 18
- Permanent settings in programming mode 23
- Personalising products 25
- Preparation 15, 17
 - At the touch of a button 15
 - Caffè latte 17
 - Cappuccino 17
 - Coffee 16
 - Espresso 16
 - Espresso macchiato 17
 - Flat white 17
 - Ground coffee 17
 - Hot water 19
 - Latte macchiato 17
 - Ristretto 16
 - Two coffees 16
 - Two espressi 16
 - Two ristretti 16
 - Two speciality coffees 16
 - Using the product selector 15
- Preparation options 15
- Problems
 - Troubleshooting 41
- Product selector view 15
- Product settings
 - Adjusting 24
- Programming mode 23
 - Adding products to the start screen 25
 - Automatic switch-off 26
 - Display settings 28
 - Duplicating products 25
 - Energy-saving mode 27
 - Language 29
 - Querying information 30
 - Restore factory settings 29
 - Setting the water hardness 27
 - Unit for amount of water 28
- Proper use 6

Q

Querying information 30

R

Regular maintenance 21

Rinsing

Machine 31

Ristretto 16

Two ristretti 16

Rotary Selection 15

Rotary Switch 5

S

Safety 6

Safety information 6

Service socket 4

Settings

Permanent settings in programming
mode 23

Setting up

Setting up the machine 10

Short operating instructions 10

Spout

Hot-water spout 4

Switching off 22

Switching on 20

Switch-off

Automatic switch-off 26

Symbol description 3

T

Technical data 44

Tel 48

Transport 43

Troubleshooting 41

Two products 16

U

Unit for amount of water 28

Use, First-time 11

W

Water hardness

Determining the water hardness 10

Setting the water hardness 27

Water tank 4

Descaling 39

Filling 20

Website 10

Wireless connection 9, 12, 14, 34, 35, 44

11 JURA contact details / Legal information

JURA Elektroapparate AG
 Kaffeeweltstrasse 10
 CH-4626 Niederbuchsiten
 Tel. +41 (0)62 38 98 233

- @ You will find additional contact details for your country at **jura.com**.
- @ If you need assistance with using your machine, you can find this at **jura.com/service**.

- Directives** The machine complies with the following directives:
- 2014/35/EU – Low Voltage Directive
 - 2014/30/EU – Electromagnetic Compatibility
 - 2009/125/EC – Ecodesign Directive
 - 2011/65/EU – RoHS Directive
 - 2014/53/EU – Wireless Voltage Directive

A detailed EU Declaration of Conformity for your J6 can be found at **jura.com/conformity**.

- Technical changes** We reserve the right to make technical changes. The diagrams used in these instructions for use are for illustration purposes only and do not represent the original colours of the machine. Some details of your JURA may vary.

- Feedback** Your opinion is important to us! Use the contact details at **jura.com**.

- Copyright** The instructions for use contain information which is protected by copyright. It is not permitted to photocopy these instructions for use or translate them into another language without the prior written consent of JURA Elektroapparate AG.