

Changing the filter

⚠ These short operating instructions are not a replacement for the instructions for use. In the interests of safety, always read the safety information and warnings first.

1 - "Filter" symbol lights up

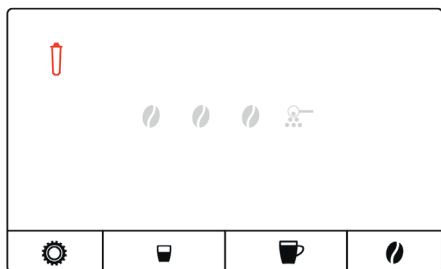

2 - Remove the water tank

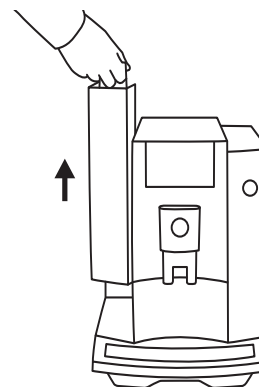

3 - Empty water tank

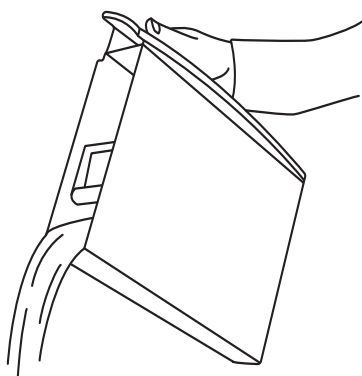

4 - Turn the filter

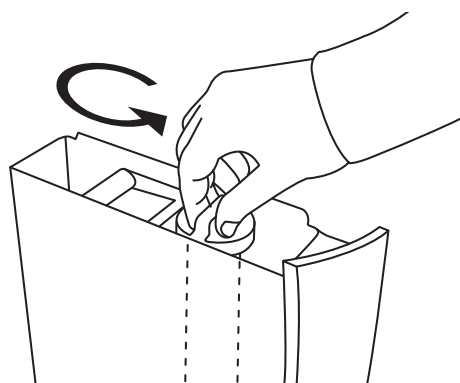

5 - Remove the filter

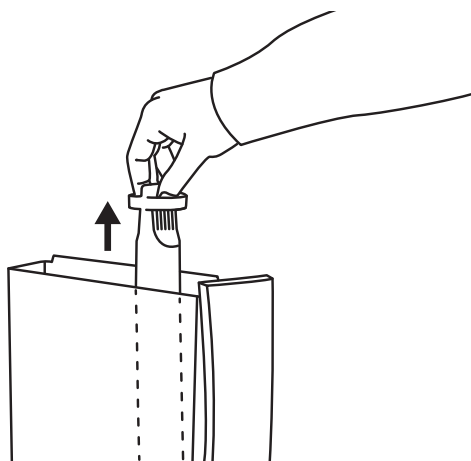

6 - Place the extension on the new filter cartridge

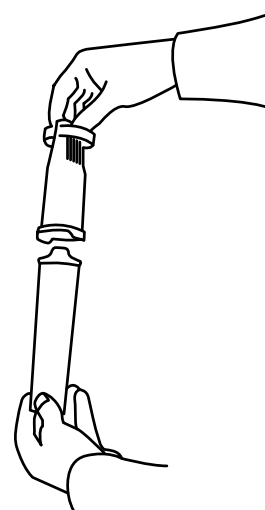

Changing the filter

⚠ These short operating instructions are not a replacement for the instructions for use. In the interests of safety, always read the safety information and warnings first.

7 - Insert the filter

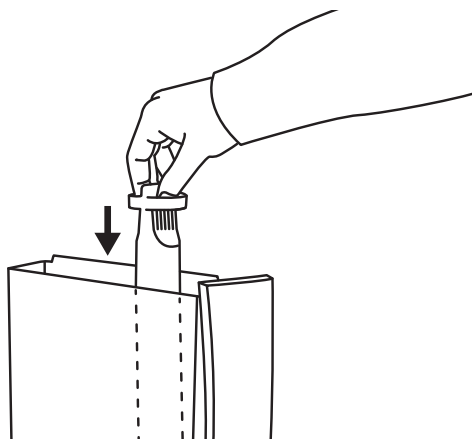

8 - Turn the filter

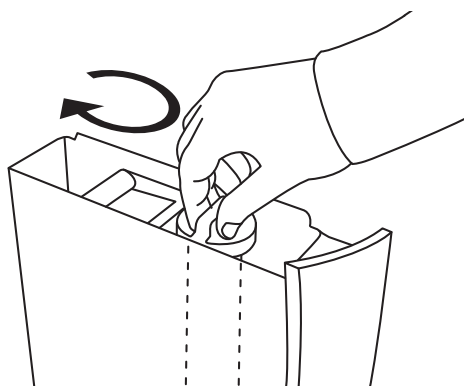

9 - Fill the water tank

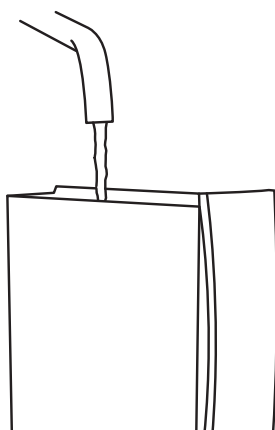

10 - Insert the water tank

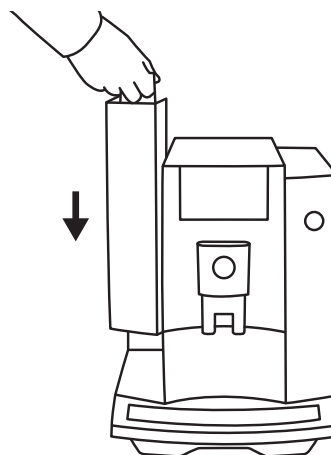

11 - Symbols flash from right to left



12 - Place the receptacle under the hot-water spout

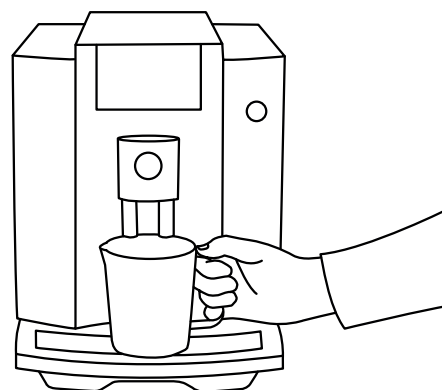

Changing the filter

⚠ These short operating instructions are not a replacement for the instructions for use. In the interests of safety, always read the safety information and warnings first.

13 - Turn the switch anticlockwise

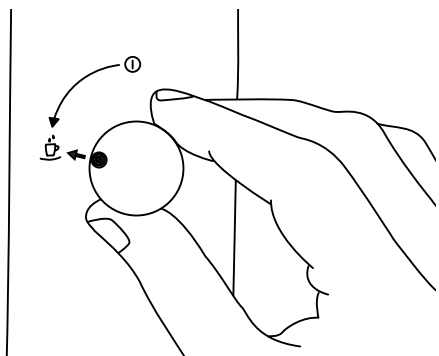

14 - Water flows out of the hot-water spout

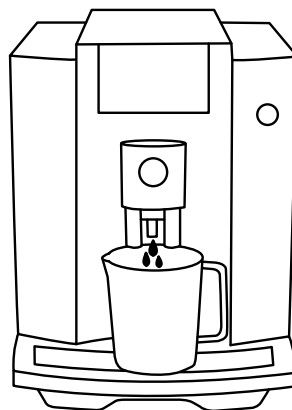

15 - Symbols flash from left to right

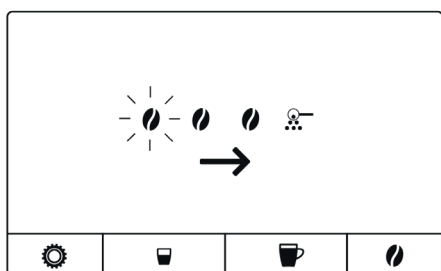

16 - Turn the switch clockwise

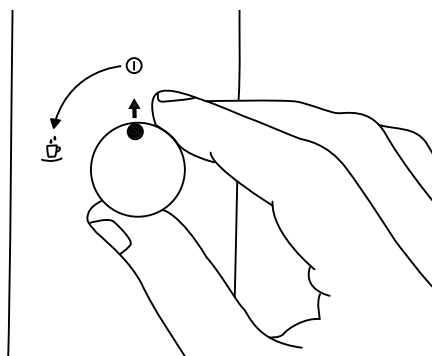

17 - "Drip tray" symbol lights up



18 - Remove the drip tray

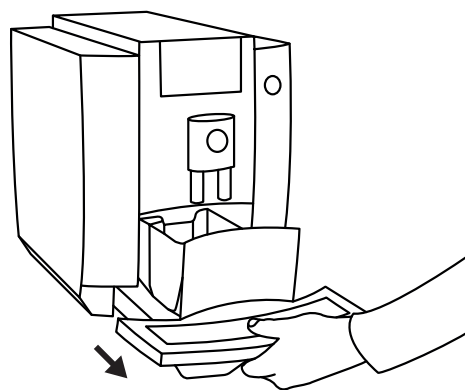

Changing the filter

⚠ These short operating instructions are not a replacement for the instructions for use. In the interests of safety, always read the safety information and warnings first.

19 - Empty the drip tray

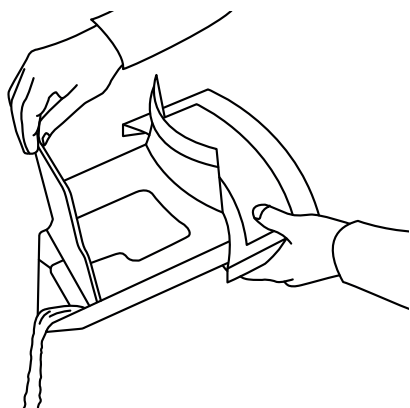

20 - Empty the coffee grounds container

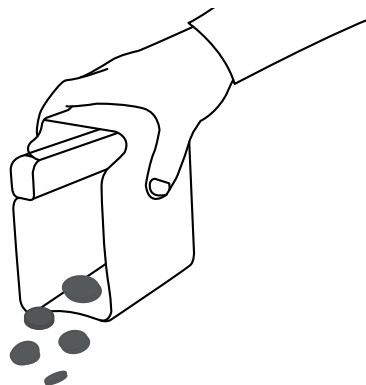

21 - Insert the drip tray

