

Descaling the machine

⚠ These short operating instructions are not a replacement for the instructions for use. In the interests of safety, always read the safety information and warnings first.

1 - "Descaling" symbol lights up

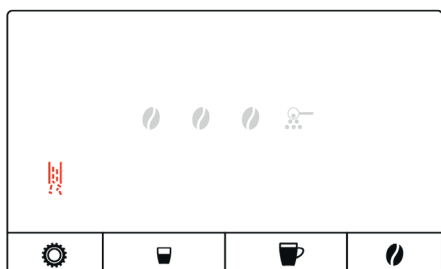

2 - Press the "Programming mode" button for approx. 3 sec

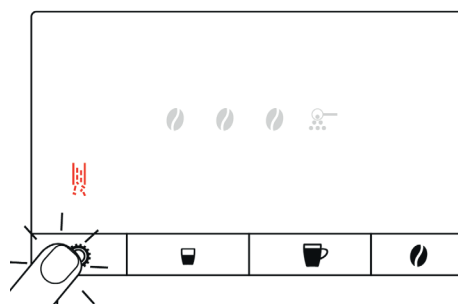

approx. 3 sec.

3 - "Drip tray" symbol lights up

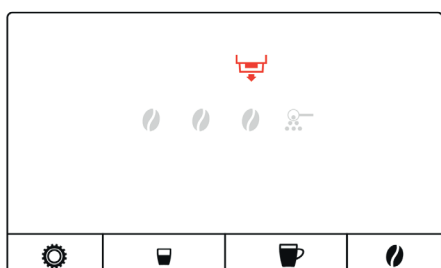

4 - Remove the drip tray

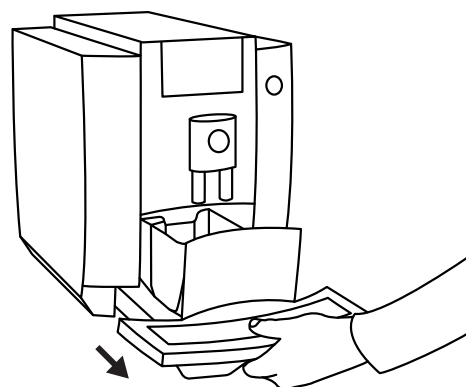

5 - Empty the drip tray

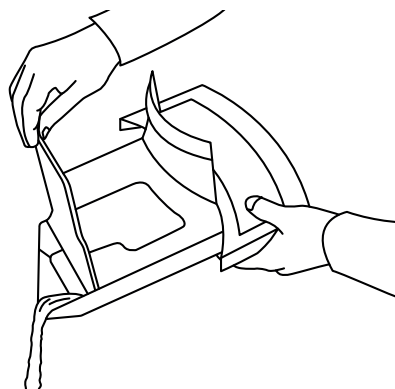

6 - Empty the coffee grounds container



Descaling the machine

⚠ These short operating instructions are not a replacement for the instructions for use. In the interests of safety, always read the safety information and warnings first.

7 - Insert the drip tray

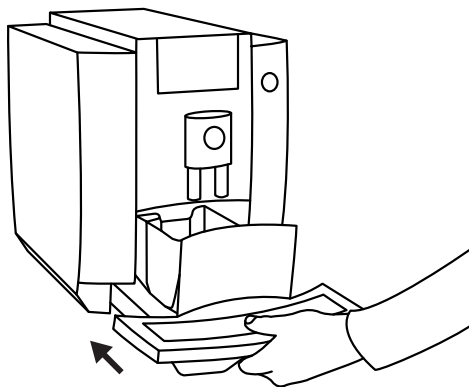

8 - "Water tank" symbol flashes



9 - Place the receptacle under the hot-water spout

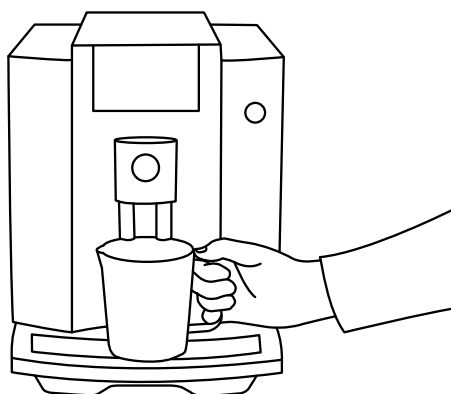

10 - Remove the water tank

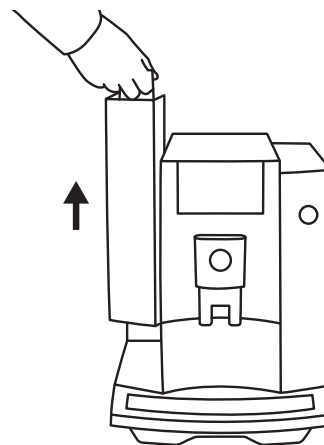

11 - Empty water tank

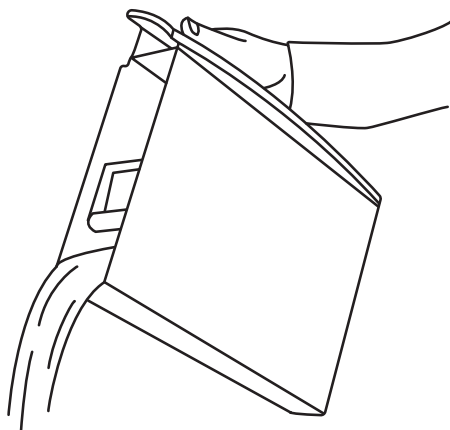

12 - Dissolve JURA descaling tablets

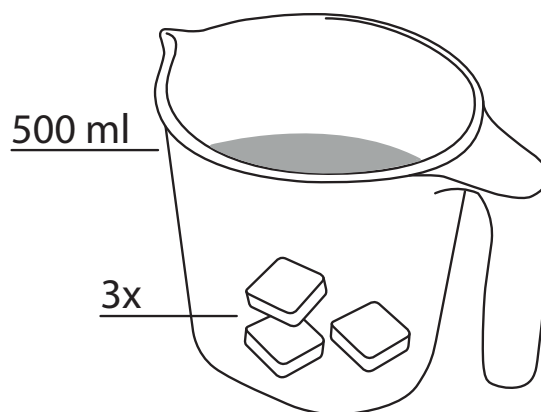

Descaling the machine

⚠ These short operating instructions are not a replacement for the instructions for use. In the interests of safety, always read the safety information and warnings first.

13 - Pour the solution into the water tank

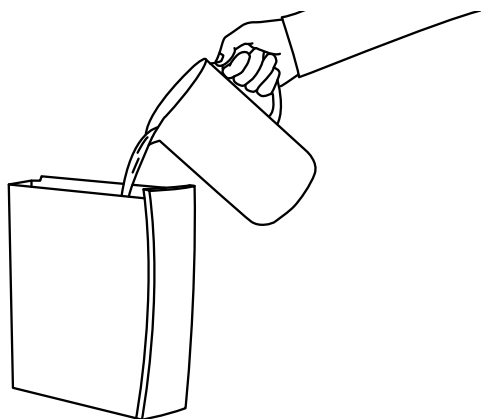

14 - Insert the water tank

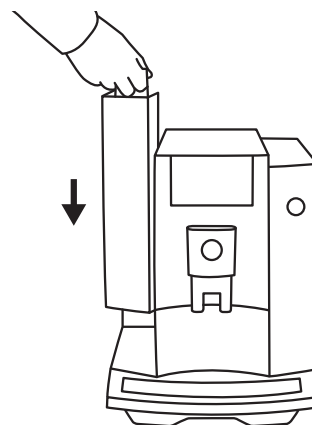

15 - Symbols flash from right to left

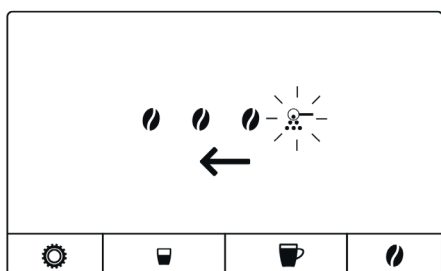

16 - Turn the switch anticlockwise

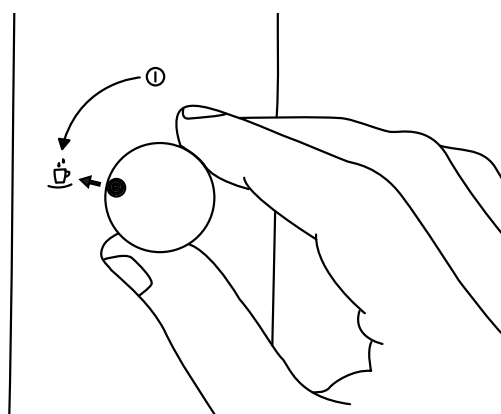

17 - Water flows out of the hot-water spout

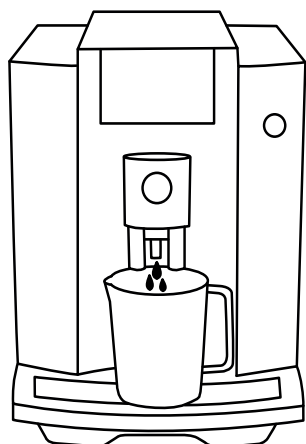

18 - Symbols flash from left to right

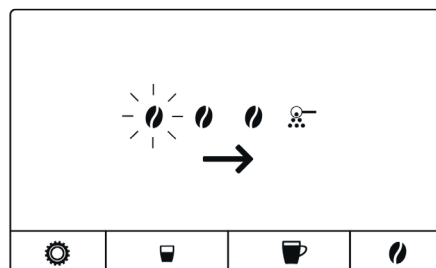

Descaling the machine

⚠ These short operating instructions are not a replacement for the instructions for use. In the interests of safety, always read the safety information and warnings first.

19 - Turn the switch clockwise

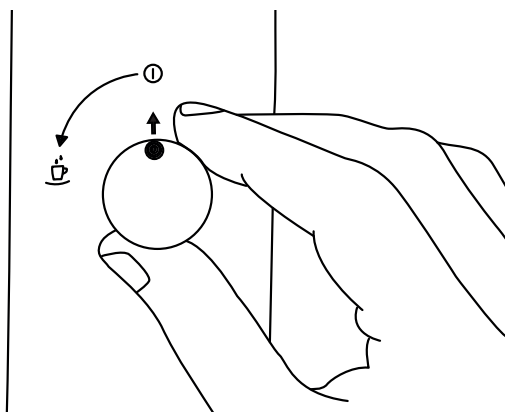

20 - "Drip tray" symbol lights up

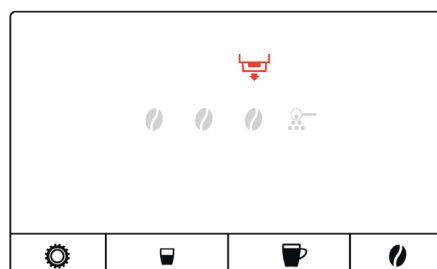

21 - Remove the drip tray

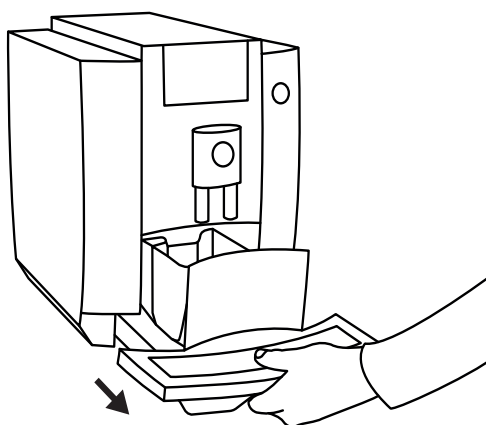

22 - Empty the drip tray

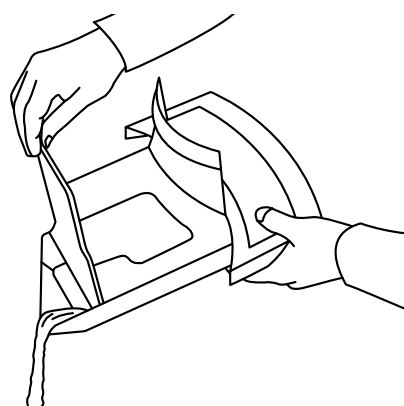

23 - Empty the coffee grounds container

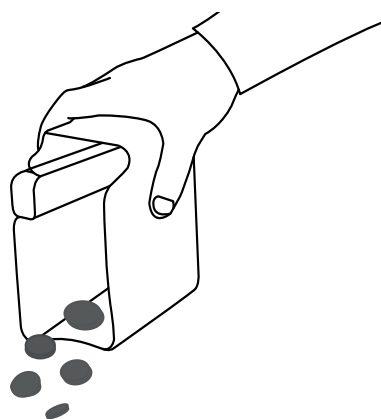

24 - Insert the drip tray

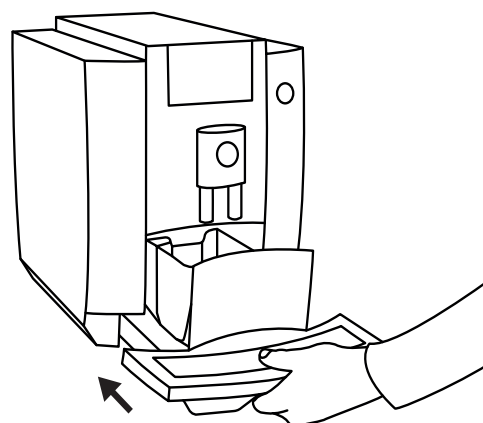

Descaling the machine

⚠ These short operating instructions are not a replacement for the instructions for use. In the interests of safety, always read the safety information and warnings first.

25 - "Water tank" symbol lights up

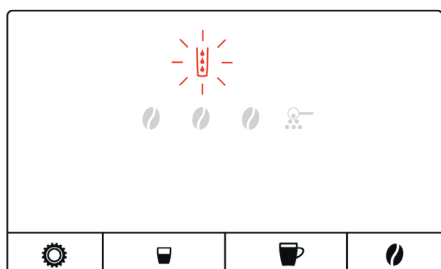

26 - Remove the water tank

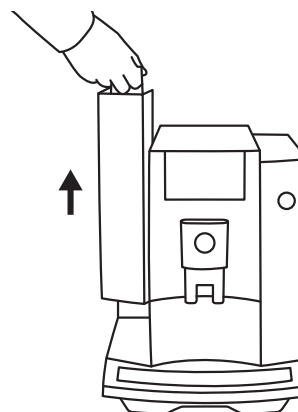

27 - Rinse out the water tank (fill and empty 3 times)

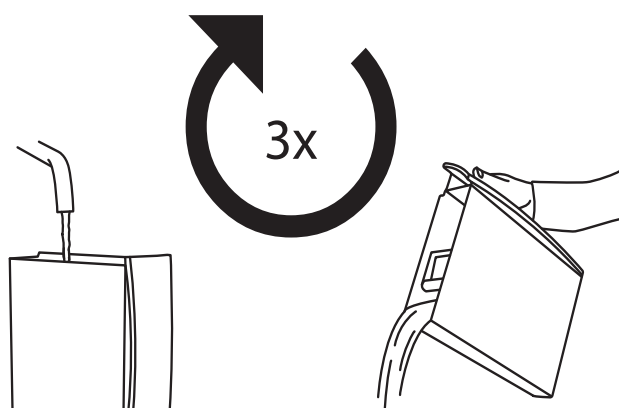

28 - Fill the water tank

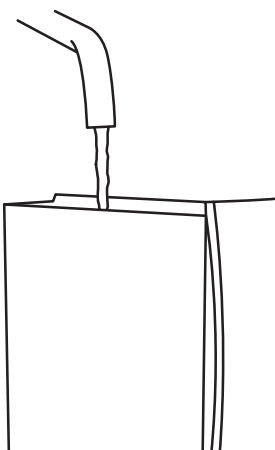

29 - Insert the water tank

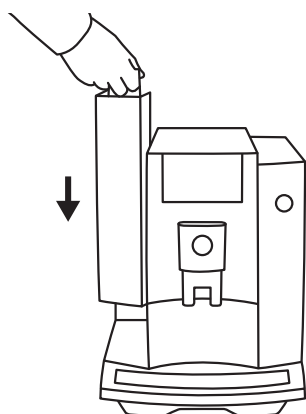

30 - Symbols flash from right to left

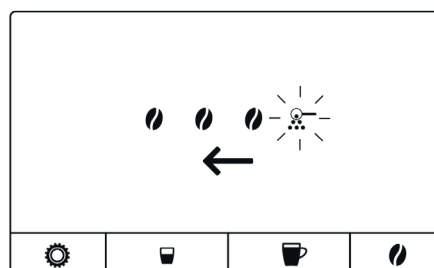

Descaling the machine

⚠ These short operating instructions are not a replacement for the instructions for use. In the interests of safety, always read the safety information and warnings first.

31 - Place the receptacle under the hot-water spout

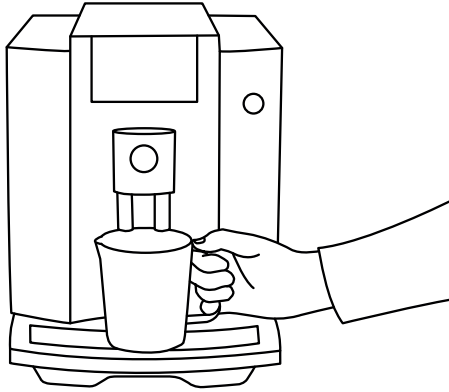

32 - Turn the switch anticlockwise

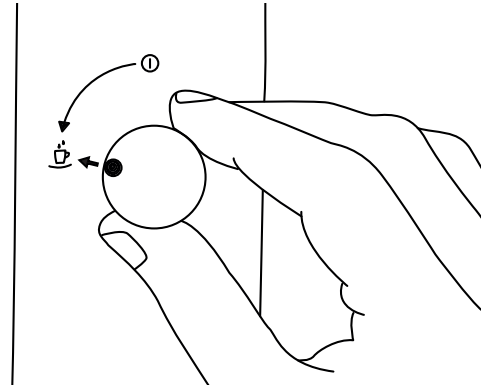

33 - Water flows out of the hot-water spout

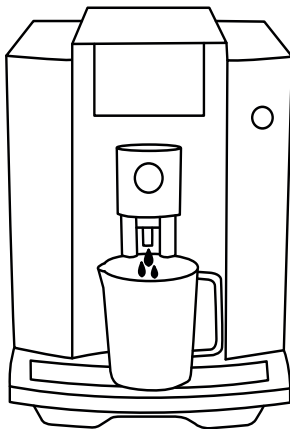

34 - Symbols flash from left to right

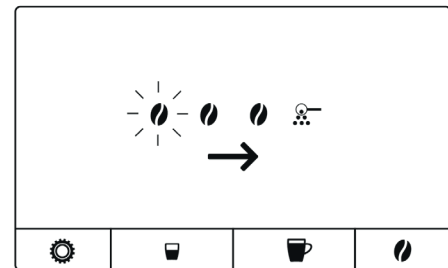

35 - Turn the switch clockwise

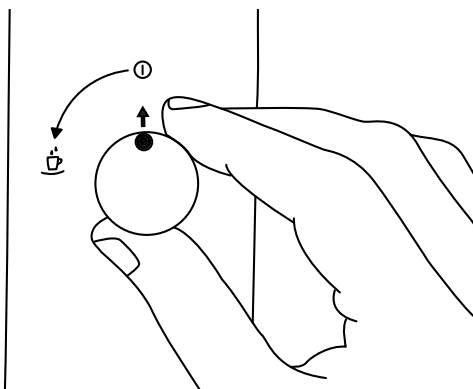

36 - "Drip tray" symbol lights up

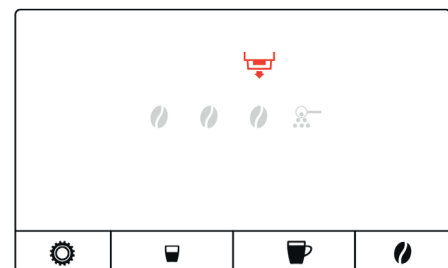

Descaling the machine

⚠ These short operating instructions are not a replacement for the instructions for use. In the interests of safety, always read the safety information and warnings first.

37 - Remove the drip tray

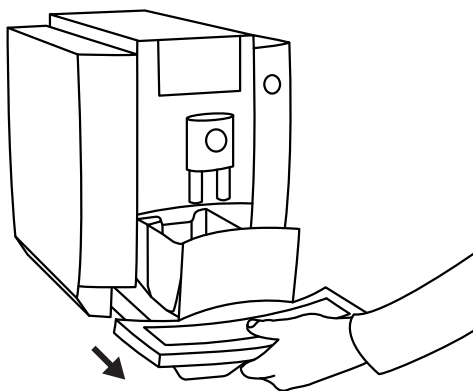

38 - Empty the drip tray

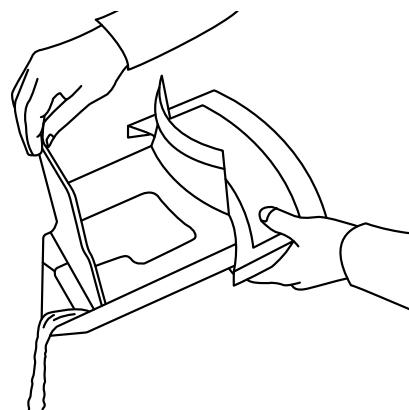

39 - Empty the coffee grounds container

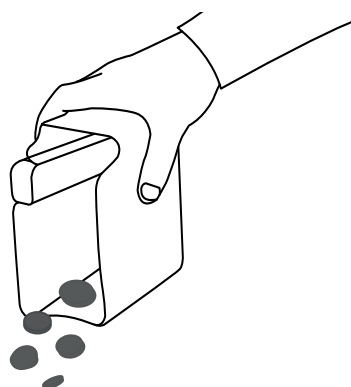

40 - Insert the drip tray

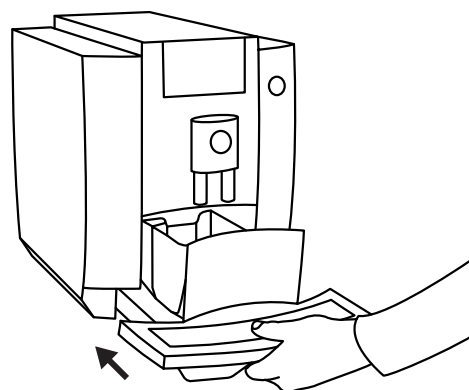

41 - Symbols flash 3x

